



Caratteristiche: Forma rassicurante e concreta, elegante e confortevole, misure "generose". La collezione offre un'ampia gamma di divani, elementi, laterali, angoli che abbinati a piacere offrono innumerevoli combinazioni. Holden è disponibile nella versione "BASE" (senza cuscini-schienali) da completare con i cuscini-schienali scelti fra le diverse misure a disposizione, avendo quindi la possibilità di progettare il divano a piacimento, e nelle versioni "A" e "B": la versione "A" è fornita con schienali di forma classica tradizionale e la versione "B" con cuscini-schienali (cm. 58x58) più accattivanti ed informali in quantità predefinita. Alcuni elementi come i terminali e la dormeuse sono disponibili in due diverse misure di profondità, 103 e 118 cm. Un elemento distintivo importante è dato dalla possibilità di scegliere tra due diverse misure di bracciolo: largo cm. 26 alto cm. 51, oppure il bracciolo BIG largo cm. 39 alto cm. 49. Il rivestimento è completamente sfoderabile. Holden è inoltre attrezzabile con il tavolino Argo. **Struttura:** Fusto in legno massello e multistrato, imbottito in poliuretano espanso indeformabile a densità differenziata, molleggio con nastri elastici intrecciati. Prerivestimento con tela di cotone accoppiata con fibra poliestere. Piedini in faggio laccato colore nero. **Imbottitura:** Cuscini-schienali tipo "A" in piuma lavata e sterilizzata con inserto in poliuretano; cuscini-schienali tipo "B" e "XL" interamente in piuma lavata e sterilizzata. Cuscini seduta in piuma con inserto in poliuretano sempre in versione cuscini divisi. Il cuscino di seduta in piuma offre un comfort speciale oltre a donare un aspetto piacevolmente vissuto, proprio della piuma, che va accettato in quanto inevitabile. Su richiesta si forniscono i cuscini di seduta in poliuretano e fibra poliestere e, in questa versione, sono disponibili sia unici che divisi.

Features: A reassuring, solid shape, elegant and comfortable, "generous" proportions. This collection presents a wide array of settees, side elements, corners that can form countless different combinations. Holden is available in the "BASE" version (without backrest cushions), which has to be equipped with backrest cushions to be chosen between several sizes. This allows the end customer to design his own sofa, in accordance with his taste. Holden can also be supplied in the version "A" and in the version "B", with two different types of backrest cushions: the classic shape type "A" and the attractive, informal type "B" (cm.58x58), in pre-determined quantity. Some elements such as end-pieces and the sleeper are available in two different depths, 103 and 118 cm. An important hallmark for this collection is the possibility to choose between two different sizes of armrest, one it's 26 cm thick 51 cm high, or the BIG armrest 39 cm thick 49 cm high. The covers are completely removable. Besides, Holden can be equipped with the small table Argo. **Structure:** Frame in solid wood and plywood, padded with differentiated density non-deformable foamed polyurethane, sprung with interwoven elastic bands. Under-covering in cotton canvas coupled with polyester fibre. Feet in black-stained beech. **Cushion padding:** Type "A" backrest cushions are made of washed and sterilised feather with polyurethane insert; type "B" and XL backrest cushions are made entirely of washed and sterilised feather. Seat cushions in down with polyurethane insert always in separate cushions. The seat cushions in goose down provide special comfort and acquire a pleasant well-worn look, which is a typical feature of down and must be accepted. On request, the seat cushions can be provided in polyurethane and polyester fibre, also available in this version as a joint cushion.

Eigenschaften: Beruhigende und konkrete Optik, elegant und bequem, großzügige Maße. Die Kollektion bietet eine breitgefächerte Serie an Sofas, Seiten- und Eckelemente, welche durch das Zusammenfügen nach freier Wahl unzählige Kombinationen bieten. Holden ist erhältlich in der Variante „BASIS“ (ohne Rückenissen), die durch einige Rückenissen ergänzt werden muss und zwischen den verschiedenen verfügbaren Maßen gewählt werden können. Dies erlaubt dem Kunden, seine eigenen Wünsche zu realisieren und sein eigenes Sofa zu kreieren. Dazu existieren zwei Varianten, "A" und "B": Variante "A" ist mit geraden Rückenissen in klassischer, traditioneller Form lieferbar; Variante "B" mit Wurfkissen (58x58 cm), etwas legerer und informeller, in vorgegebener Menge. Einige Elemente, wie die Endteile und die Dormeuse, sind in den zwei Tiefen 103 und 118 cm verfügbar. Ein wichtiges Unterscheidungsmerkmal ist durch die Möglichkeit gegeben, zwischen zwei verschiedenen Größen der Armlehne zu wählen: 26 cm breit, 51 cm hoch oder die Armlehne BIG 39 cm breit und 49 cm hoch. Der Bezug ist komplett abziehbar. Holden kann ebenfalls mit dem Beistelltisch Argo ergänzt werden. **Struktur:** Korpus aus massiver Buche und Mehrschichtholz, Unterfederung durch geflochtene Elastikgurte. Schonbezug aus Baumwolle mit Polyesterfaser. Füße aus schwarz lackierter Buche. **Polster:** Rückenissen Typ "A" aus gewaschenen und sterilisierten Federn mit Polyurethan-Einsatz, Rückenissen Typ "B" nur aus gewaschenen und sterilisierten Federn. Sitzkissen mit Federn und Polyurethaneinsatz, stets als getrennte Kissen. Die Sitzkissen aus Federn bieten einen besonderen Komfort und aufgrund der Federn einen speziellen, legeren Look, welcher als solcher akzeptiert werden muss. Auf Anfrage können die Sitzkissen aus Polyurethan und Polyesterfaser bestehen, und in dieser Ausführung, auch als durchgehende Sitzkissen.

PIEDE FOOT FUß

Massello di faggio laccato color nero.
Solid beech wood stained black.
Schwarz lackierte massive Buche.

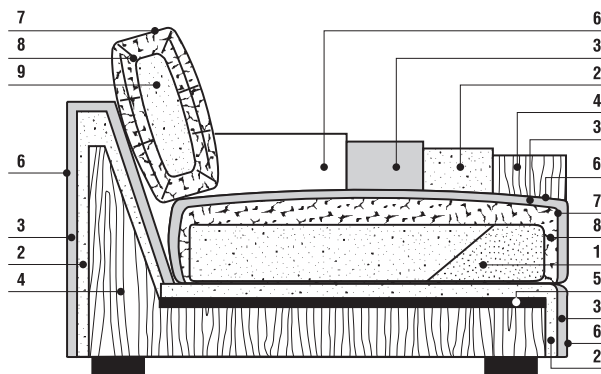

SEZIONE SECTION SEKTION

- 1: Poliuretano a densità differenziata.
Differentiated density polyurethane.
Polyurethan unterschiedlicher Dichte.
- 2: Poliuretano. Polyurethane. Polyurethan.
- 3: Fibra Poliestere. Polyester Fibre.
Polyesterfaser.
- 4: Fusto in legno massello e multistrato.
Frame in solid wood and plywood.
Korpus aus Massivholz, oder schichtverleimt.
- 5: Nastri elastici. Elastic belts. Elastische Gurte.
- 6: Fodera in tela. Fabric lining. Schonbezug.
- 7: Fodera in tessuto antipiuma.
Featherproof fabric cover.
Federnundurchlässiger Bezug des Kisseninlets.
- 8: Piuma. Down. Federfüllung.
- 9: Inserto in Poliuretano. Polyurethane insert.
Einsatz aus Polyurethan.

HOLDEN VERSIONE BASE

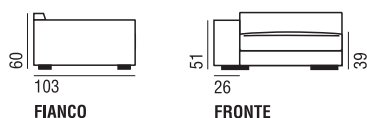

HOLDEN VERSIONE A

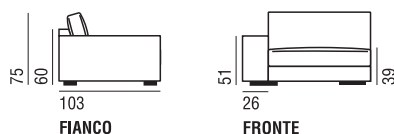

HOLDEN VERSIONE B

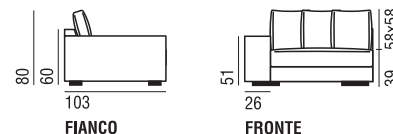

HOLDEN BIG VERSIONE BASE

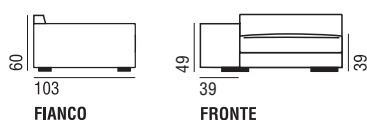

HOLDEN BIG VERSIONE A

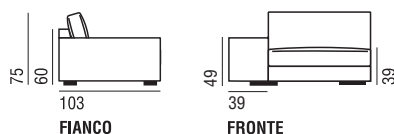

HOLDEN BIG VERSIONE B

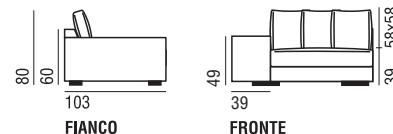

HOLDEN MODULI CON BRACCIOLI 26 CM. VERSIONE A

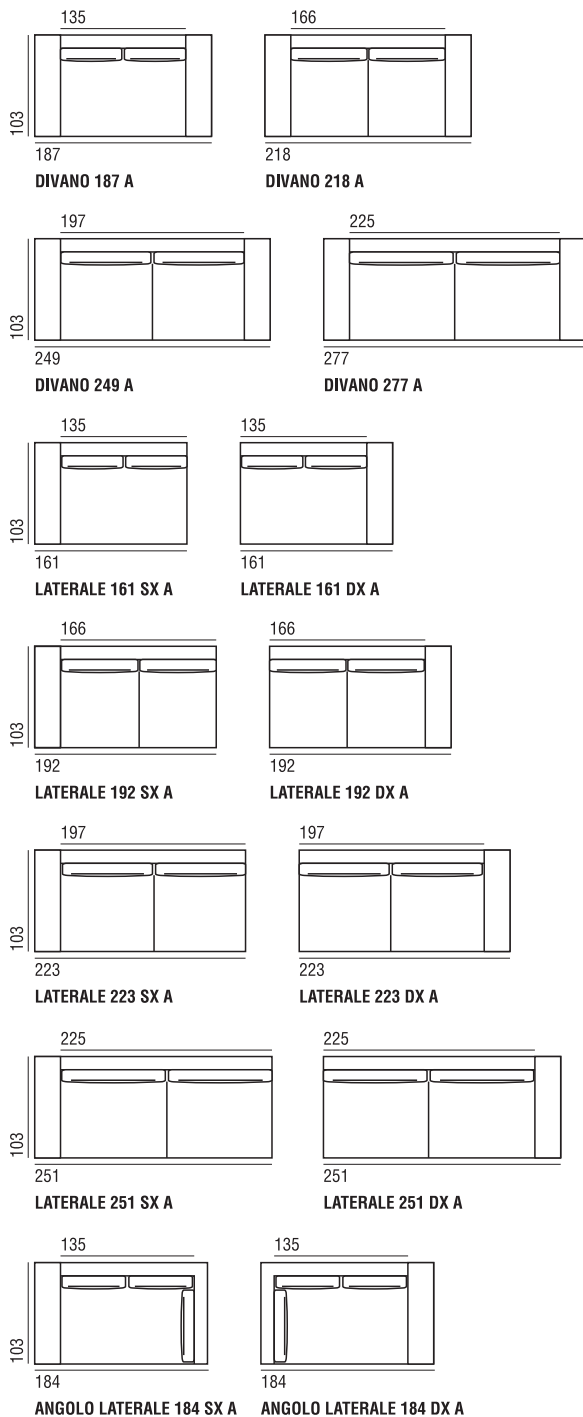

HOLDEN MODULI CON BRACCIOLI 26 CM. VERSIONE B

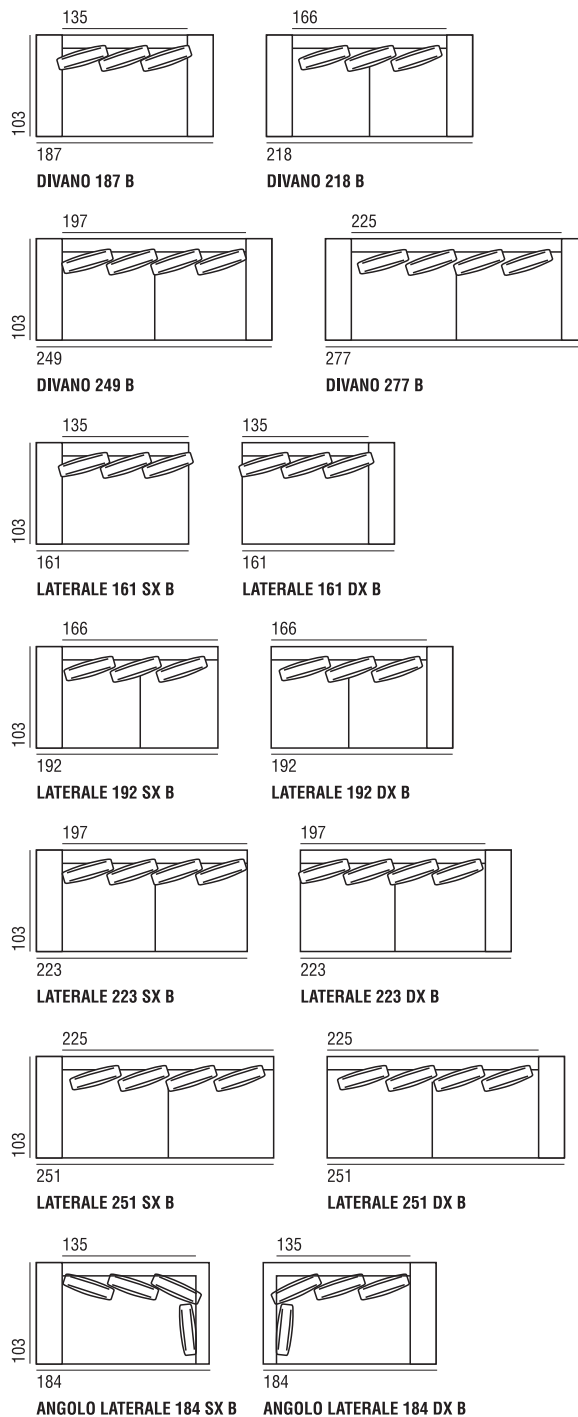

HOLDEN MODULI CON BRACCIOLI 26 CM. VERSIONE A

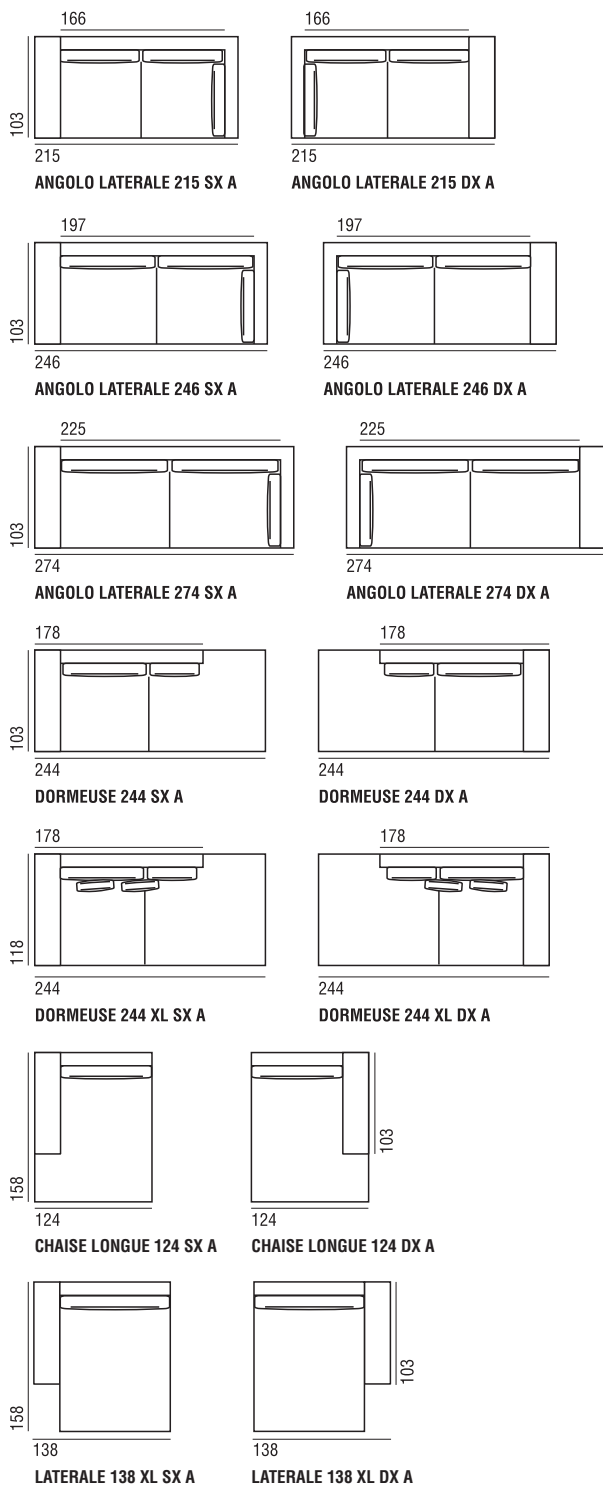

HOLDEN MODULI CON BRACCIOLI 26 CM. VERSIONE B

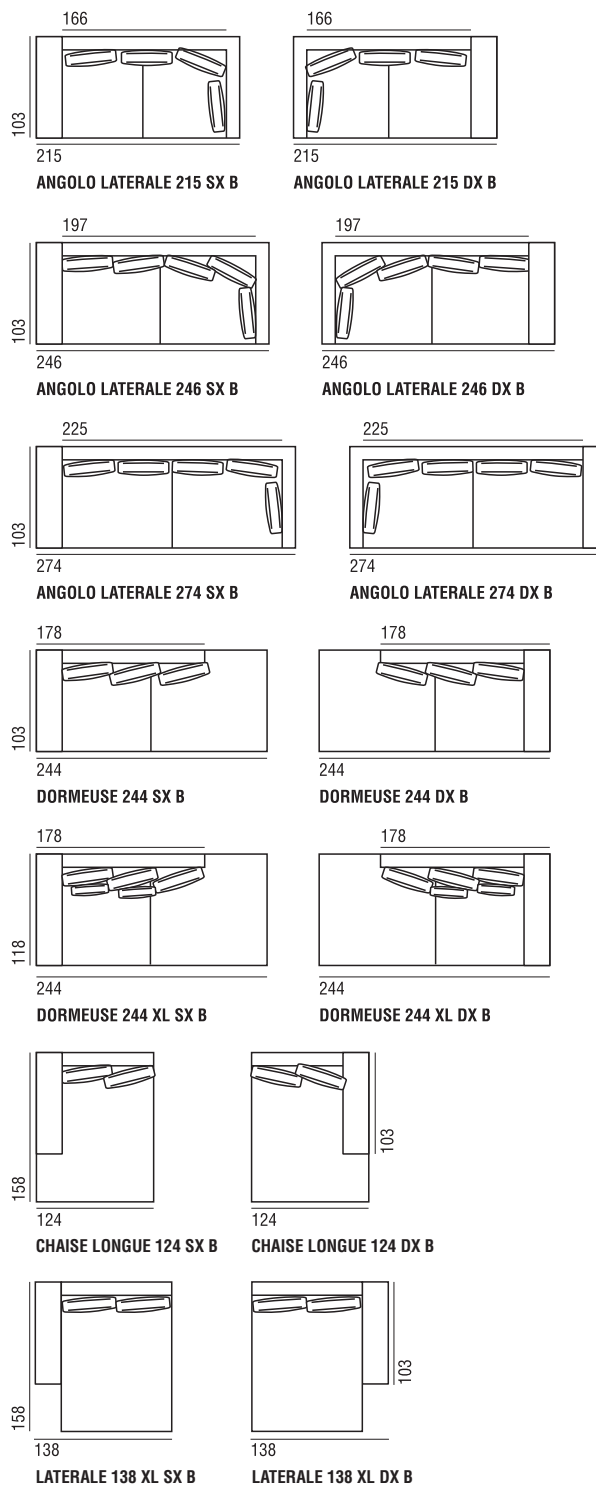

HOLDEN MODULI CON BRACCIOLO BIG 39 CM. VERSIONE A

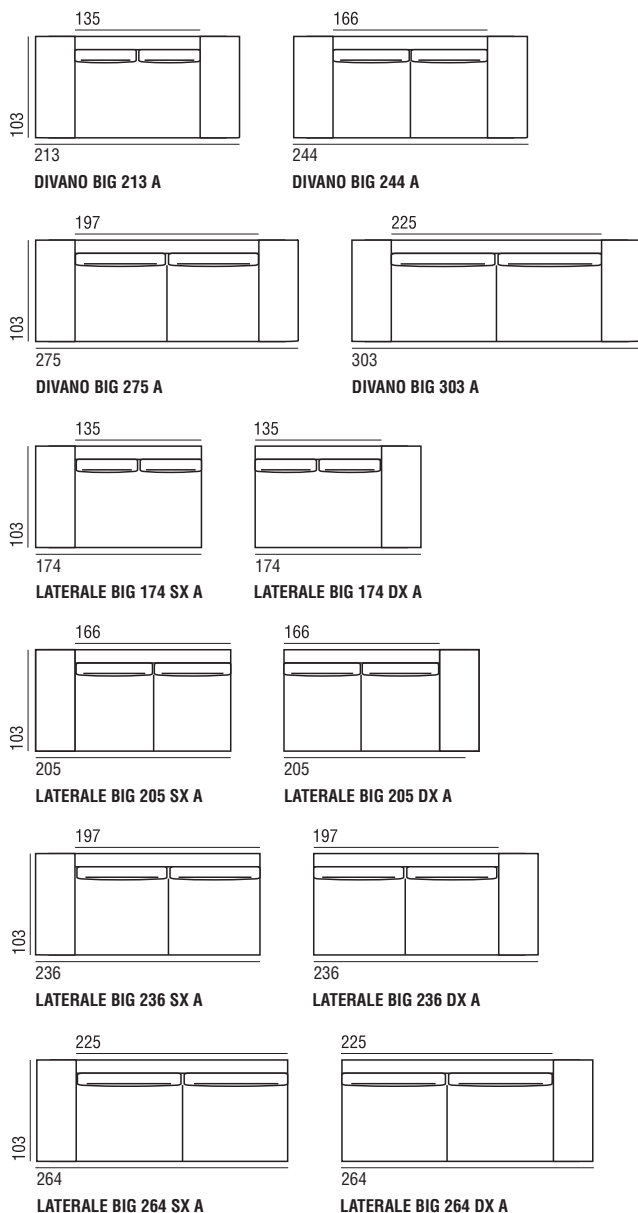

HOLDEN MODULI CON BRACCIOLO BIG 39 CM. VERSIONE B

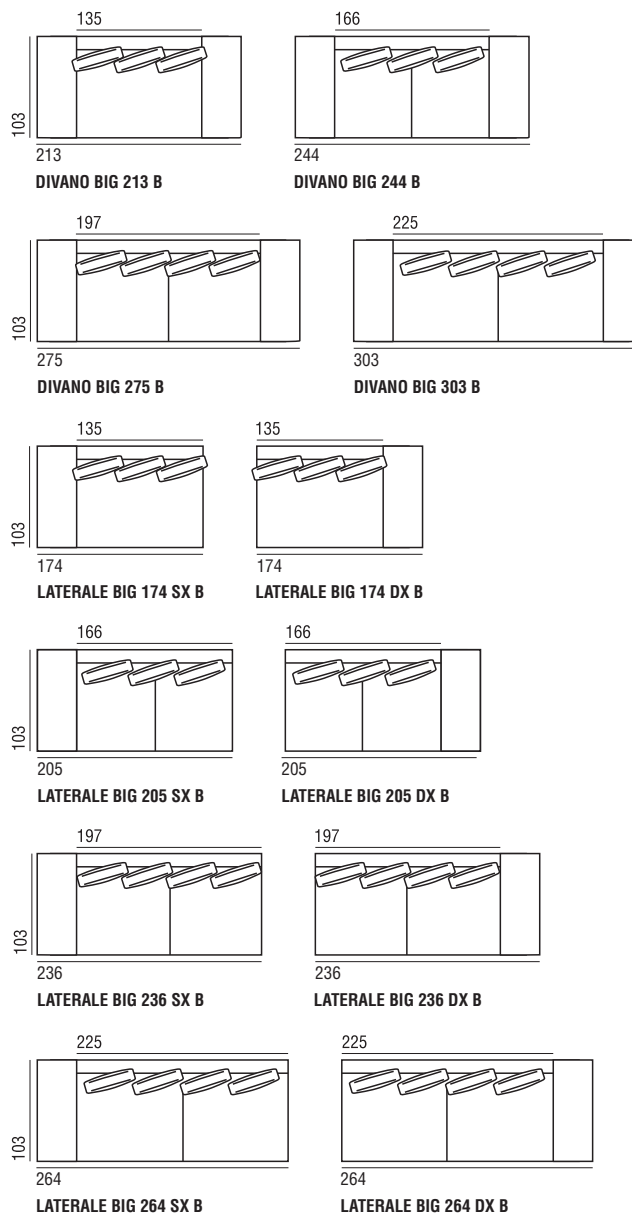

HOLDEN MODULI CON BRACCIOLO BIG 39 CM. VERSIONE A

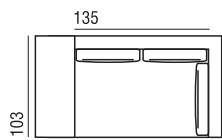

197
ANGOLO LATERALE BIG 197 SX A

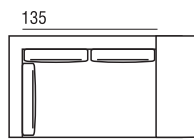

197
ANGOLO LATERALE BIG 197 DX A

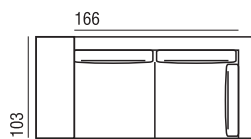

228
ANGOLO LATERALE BIG 228 SX A

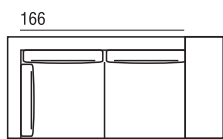

228
ANGOLO LATERALE BIG 228 DX A

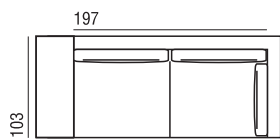

259
ANGOLO LATERALE BIG 259 SX A

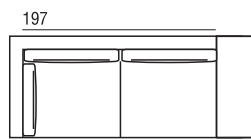

259
ANGOLO LATERALE BIG 259 DX A

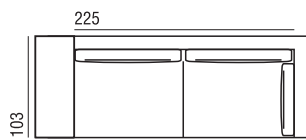

287
ANGOLO LATERALE BIG 287 SX A

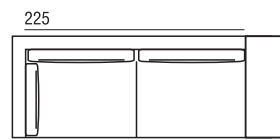

287
ANGOLO LATERALE BIG 287 DX A

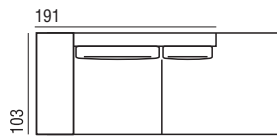

257
DORMEUSE BIG 257 SX A

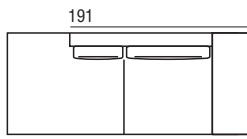

257
DORMEUSE BIG 257 DX A

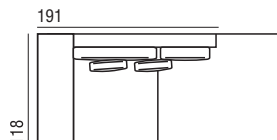

257
DORMEUSE BIG 257 XL SX A

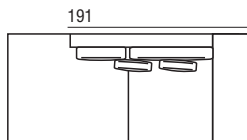

257
DORMEUSE BIG 257 XL DX A

HOLDEN MODULI CON BRACCIOLO BIG 39 CM. VERSIONE B

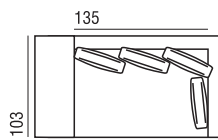

197
ANGOLO LATERALE BIG 197 SX B

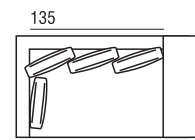

197
ANGOLO LATERALE BIG 197 DX B

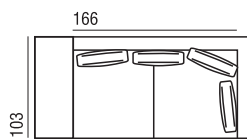

228
ANGOLO LATERALE BIG 228 SX B

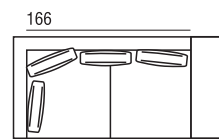

228
ANGOLO LATERALE BIG 228 DX B

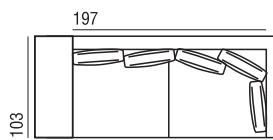

259
ANGOLO LATERALE BIG 259 SX B

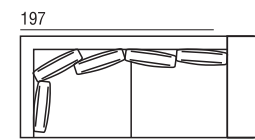

259
ANGOLO LATERALE BIG 259 DX B

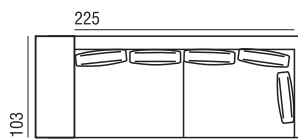

287
ANGOLO LATERALE BIG 287 SX B

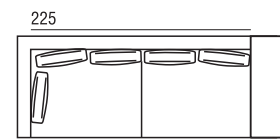

287
ANGOLO LATERALE BIG 287 DX B

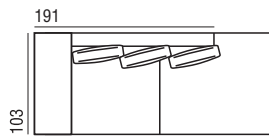

257
DORMEUSE BIG 257 SX B

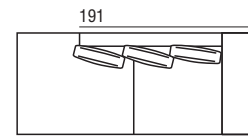

257
DORMEUSE BIG 257 DX B

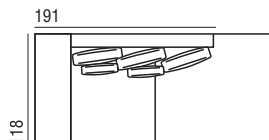

257
DORMEUSE BIG 257 XL SX B

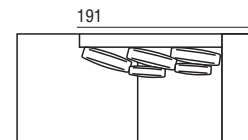

257
DORMEUSE BIG 257 XL DX B

HOLDEN MODULI CON BRACCIOLO BIG 39 CM. VERSIONE A

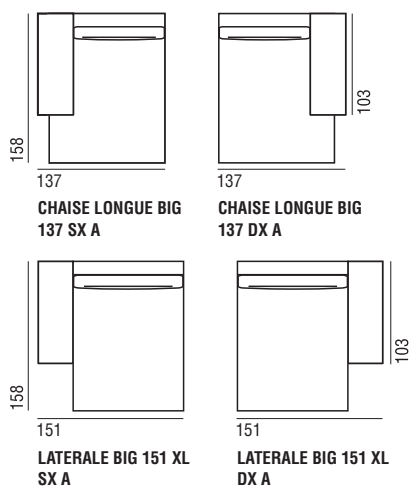

HOLDEN MODULI CON BRACCIOLO BIG 39 CM. VERSIONE B

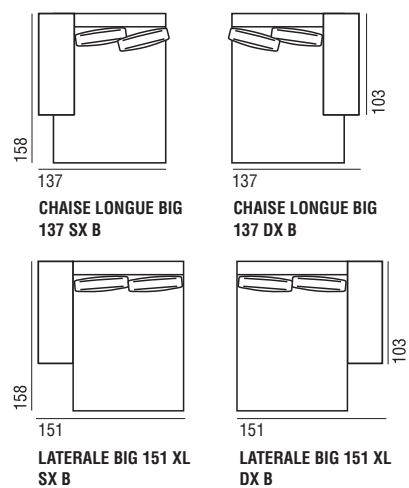

HOLDEN MODULI SENZA BRACCIOLI VERSIONE A

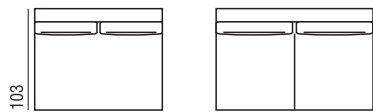

135
ELEMENTO 135 A

166
ELEMENTO 166 A

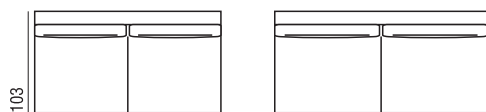

197
ELEMENTO 197 A

225
ELEMENTO 225 A

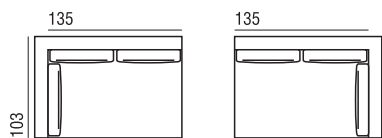

135
158
ANGOLO 158 SX A

135
158
ANGOLO 158 DX A

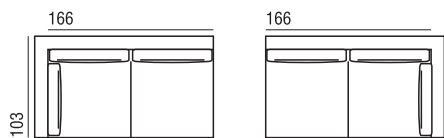

166
189
ANGOLO 189 SX A

166
189
ANGOLO 189 DX A

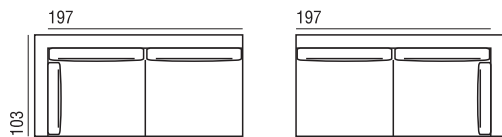

197
220
ANGOLO 220 SX A

197
220
ANGOLO 220 DX A

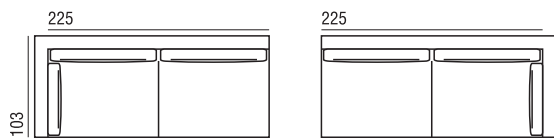

225
248
ANGOLO 248 SX A

225
248
ANGOLO 248 DX A

HOLDEN MODULI SENZA BRACCIOLI VERSIONE B

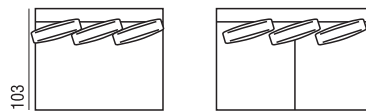

135
ELEMENTO 135 B

166
ELEMENTO 166 B

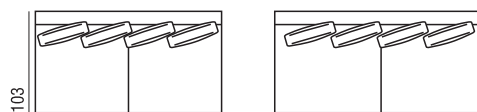

197
ELEMENTO 197 B

225
ELEMENTO 225 B

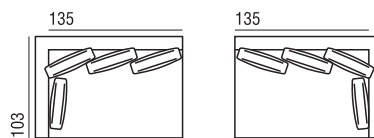

135
158
ANGOLO 158 SX B

135
158
ANGOLO 158 DX B

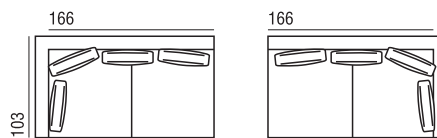

166
189
ANGOLO 189 SX B

166
189
ANGOLO 189 DX B

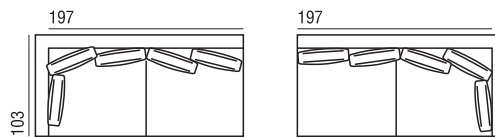

197
220
ANGOLO 220 SX B

197
220
ANGOLO 220 DX B

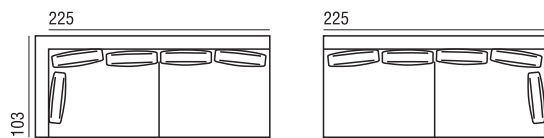

225
248
ANGOLO 248 SX B

225
248
ANGOLO 248 DX B

HOLDEN MODULI SENZA BRACCIOLI VERSIONE A

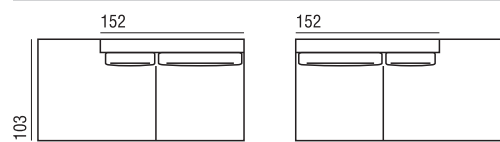

TERMINALE 218 SX A

TERMINALE 218 DX A

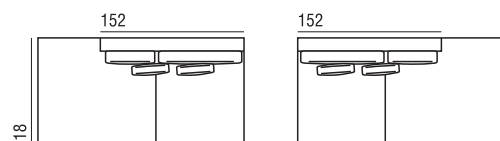

TERMINALE 218 XL SX A

TERMINALE 218 XL DX A

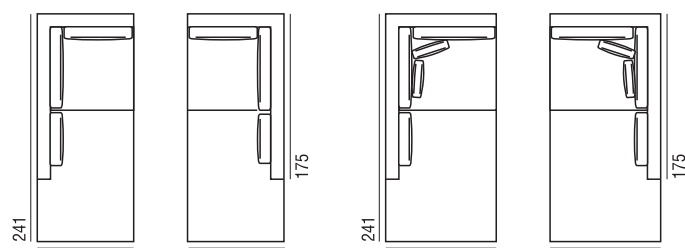

DORMEUSE ANGOLO 103 SX A

DORMEUSE ANGOLO 103 DX A

DORMEUSE ANGOLO 118 SX A

DORMEUSE ANGOLO 118 DX A

HOLDEN MODULI SENZA BRACCIOLI VERSIONE B

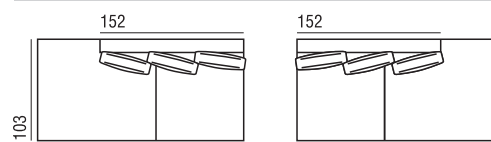

TERMINALE 218 SX B

TERMINALE 218 DX B

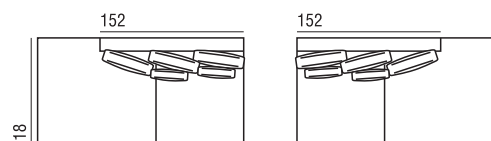

TERMINALE 218 XL SX B

TERMINALE 218 XL DX B

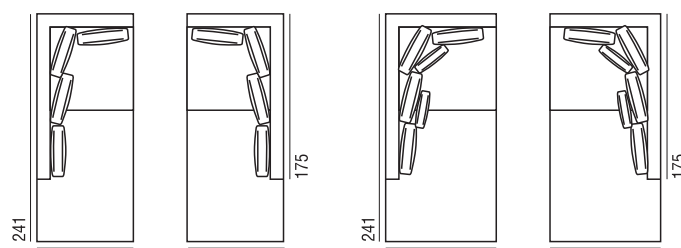

DORMEUSE ANGOLO 103 SX B

DORMEUSE ANGOLO 103 DX B

DORMEUSE ANGOLO 118 SX B

DORMEUSE ANGOLO 118 DX B

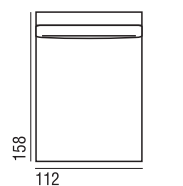

ELEMENTO 112 XL A

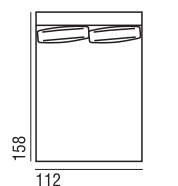

ELEMENTO 112 XL B

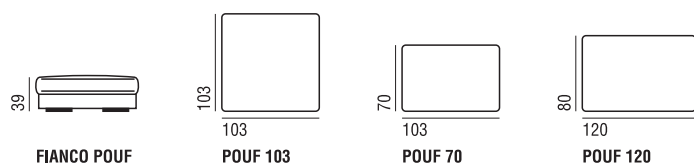

FIANCO POUF

POUF 103

POUF 70

POUF 120

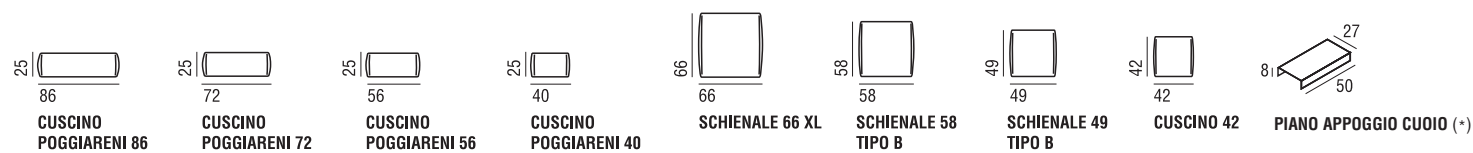

CUSCINO POGGIARENI 86

CUSCINO POGGIARENI 72

CUSCINO POGGIARENI 56

CUSCINO POGGIARENI 40

SCHIENALE 66 XL

SCHIENALE 58 TIPO B

SCHIENALE 49 TIPO B

CUSCINO 42

PIANO APPOGGIO CUOIO (*)

(*) disponibile solo con bracciolo 26 cm / available with armrest 26 cm only / nur mit Armlehne 26 cm erhältlich