

# FOLD

Design García Cumini 2014



**Caratteristiche:** Fold, grazie alla profondità di soli 85 cm, è una collezione pensata per gli spazi contenuti e raffinati che si caratterizza nel suo design e nella sua personalità per una serie di cuciture che traggono ispirazione dal sistema di chiusura della busta. Fold si compone di divani, laterali, chaise longue, dormeuse e terminale da combinare in base alle proprie esigenze. Da sottolineare la doppia funzione che i moduli con bracciolo possono svolgere: quelli con un bracciolo possono essere utilizzati sia come laterale che come angolo; quelli con due braccioli sia come divano che come angolo laterale. Allo stesso modo la dormeuse può essere utilizzata come modulo indipendente o inserita come dormeuse angolo in una composizione. Completano l'offerta la poltrona, le cui dimensioni sono più ridotte rispetto agli altri moduli, i pouf, comodi cuscini e poggiatesta. A seconda del rivestimento scelto la fodera si realizza in due diverse finiture: con cucitura ribattuta semplice o con "Punto Cavallo" (vedi pag. 106) Il "Punto Cavallo" è un'impuntura decorativa disponibile in 11 colori da abbinare a piacere al tessuto da scegliere fra quelli indicati come idonei (vedi retrocopertina listino prezzi). La finitura "Punto Cavallo" si fornisce con supplemento di prezzo. Il rivestimento è completamente e facilmente sfoderabile (ad eccezione della versione in Pelle) e i componibili vengono forniti di serie con un pratico sistema di aggancio. Fold si può attrezzare con i tavolini Blog; in particolare il tavolino Blog Alto, ideato appositamente per completare la collezione Fold, offre un valido piano d'appoggio all'altezza del bracciolo. **Versione Pelle:** La versione con rivestimento in Pelle ha una lavorazione diversa da quella in tessuto. Viene realizzata solamente con la cucitura ribattuta semplice e senza la tasca aperta posta sulla sommità del bracciolo (vedi pag. 106). **Struttura:** Fusto in legno massello e multistrato, molleggio con nastri elastici intrecciati. Il piede è in fusione disponibile nelle seguenti finiture: cromato, verniciato bianco opaco (RAL 9010), rosso opaco (RAL 3027) oppure grigio opaco (RAL 7022). **Imbottiture:** In poliuretano espanso indeformabile a densità differenziata, la seduta ha lo strato superiore in poliuretano Memory Foam e il tutto è ricoperto da uno strato di fibra poliestere, che dona un aspetto morbido e vissuto che va accettato in quanto voluto. Prerivestimento in tela bianca di cotone. I cuscini e i poggiatesta sono in piuma d'oca e anitra bianca vergine.

**Features:** Fold has been thought for limited but refined spaces, thanks to its depth of just mm 850, where its particular stitching, reminding the sealing of envelopes, characterize the design and personality of this collection. The range includes sofas, side pieces, chaise longue, dormeuse and end piece in order to answer to the different client's needs. To be emphasised is the double use of the modules with armrest: those with one armrest can be used as side- or corner pieces, while those with two arms work as sofas or as side corners. Likewise, dormeuse can be used either as a free-standing module or as a corner dormeuse when combined with other elements. Proportioned armchair, poufs comfortable cushions and lumbar cushions complete the range. According to the chosen fabric upholstery the cover can be delivered in two different finishes: single lapped seam or with Punto Cavallo (see page 106). Punto Cavallo is a decorative stitching available in 11 colours to be matched at pleasure to fabric to choose among those specified as suitable for this finish (see back cover price list). There is an up charge for the Punto Cavallo option. Covers are completely and easily removable (except for the leather version). For composition a practical connecting system is also provided. Fold can be completed with Blog small tables; in particular Blog Alto has been designed to complete the collection Fold, and offers a functional rest top at the armrest height. **Cover in leather:** finishing of the covers in leather differs from the one in fabric. Cover in leather is provided with the single lapped seam only, and without the pocket on the upper part of the armrest (see page 106). **Framework:** Frame is in solid wood and plywood, sprung with interwoven elastic bands. Feet are in cast, available in four finishes: chrome, white-matt (RAL 9010), red-matt (RAL 3027) or grey-matt (RAL 7022) painted. **Padding:** Fold is padded with differentiated density non-deformable polyurethane foam, the upper layer of the seat is in Memory Foam polyurethane finished with polyester fibre, giving a soft and aged appearance that must be accepted as it is intentional. Underlining in white cotton. Cushions and Lumbar Cushions are in goose and duck white, new feathers.

**Eigenschaften:** Dank seiner Tiefe von 85 cm, ist Fold eine Kollektion, die für etwas kleinere und elegante Räumlichkeiten gedacht ist. Ihre Nahtverarbeitung, die sich am Verschlusssystem eines Kuverts inspiriert, charakterisiert ihr Design und ihre Persönlichkeit. Die Kollektion Fold bietet Sofas, Seitenteile, Chaiselongue, Dormeuse und Endelemente, die je nach Bedarf miteinander kombiniert werden können. Hervorzuheben sei die mögliche Doppelfunktion der Elemente mit Armlehne: Elemente mit einer Armlehne können sowohl als Seitenteil als auch als Eckelement eingesetzt werden; die Elemente mit zwei Armlehnen sowohl als Sofa als auch als Seiteneckteil. Ebenso kann die Dormeuse entweder als alleinistehendes Modul oder als Eckdormeuse gestellt werden. Ein Sessel, dessen Maße, im Vergleich zu den anderen Elementen der Kollektion, reduzierter sind, rundet, zusammen mit den Hockern, bequemen Wurf- und Lendenkissen, das Angebot ab. Je nach Stoffwahl kann der Bezug in zwei unterschiedlichen Verarbeitungen realisiert werden: einfache Kappnaht oder Ziernaht „Punto Cavallo“ (siehe Seite 106). Letztere ist in 11 Farben erhältlich und kann nach Wunsch mit den dafür geeigneten Stoffen kombiniert werden (siehe Deckblatt Innenseite der Preisliste). Die Verarbeitung mit Punto Cavallo ist mit einem Aufpreis verbunden. Der Bezug ist leicht und vollständig abnehmbar (Lederfassung ausgenommen) und die Anbauelemente sind serienmäßig mit einem praktischen Verbindungssystem ausgestattet. Fold kann mit den Beistelltischen Blog ergänzt werden, insbesondere mit Blog Alto, der speziell für die Kollektion Fold gedacht ist und der eine ideale Ablagefläche in Höhe der Armlehne bietet. **Lederbezug:** Die Ausführung in Leder hat eine andere Verarbeitung als die Stoffversion. Sie wird ausschließlich mit einfacher Kappnaht und ohne die spezielle Faltung auf der Oberseite der Armlehne realisiert (siehe Seite 106). **Struktur:** Korpus aus Massiv- und Mehrschichtholz, Federung mit geflochtenen elastischen Gurten. Das gegossene Fußgestell ist in folgenden Ausführungen erhältlich: verchromt, mattlackiert in Weiß (RAL 9010), Rot (RAL 3027) oder Grau (RAL 7022). **Polsterungen:** Formstabiles Polyurethan mit differenzierten Dichten, wobei die obere Schicht des Sitzkissens aus Polyurethan „Memory Foam“ besteht und das Ganze eine Schicht Polyesterfaser überzieht, das ein weiches und „gelebtes“ Aussehen verleiht, das gewollt ist und als solches akzeptiert werden muss. Unterbezug aus weißer Baumwolle. Die Füllung der Wurf- und Lendenkissen ist aus neuen, weißen Gänse- und Entenfedern.

#### PIEDE FOOT FUSS

Fusione di metallo verniciato opaco color bianco (RAL 9010);  
fusione di metallo verniciato opaco color rosso (RAL 3027);  
fusione di metallo verniciato opaco color grigio (RAL 7022);  
fusione di metallo finitura a cromo.

Feet in cast finishing white-matt (RAL 9010) painted;  
feet in cast finishing red-matt (RAL 3027) painted;  
feet in cast finishing grey-matt (RAL 7022) painted;  
feet in cast finishing chrome.

Fuß in Metallguß mattlackiert Weiß (RAL 9010);  
Fuß in Metallguß mattlackiert Rot (RAL 3027);  
Fuß in Metallguß mattlackiert Grau (RAL 7022);  
Fuß in Metallguß verchromt.

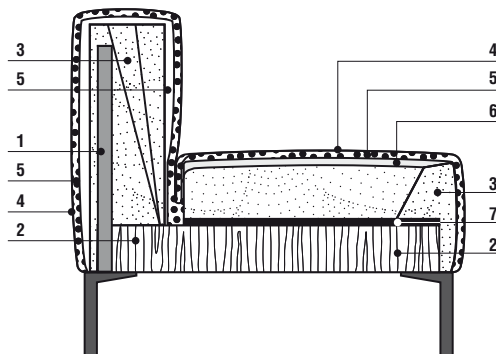
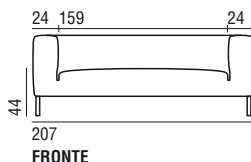
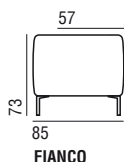
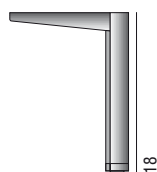

#### SEZIONE SECTION SEKTION

- 1: Pannello multistrato. Plywood base-panel. Mehrschichttholz.
- 2: Fusto in legno massello e multistrato. Frame in solid wood and plywood. Korpus aus Massiv- und Mehrschichttholz.
- 3: Poliuretano a densità differenziata. Differentiated density polyurethane. Polyurethan differenzierter Dichte.
- 4: Fodera in tela. Fabric lining. Unterbezug.
- 5: Fibra Poliestere. Polyester Fibre. Polyesterfaser.
- 6: Poliuretano Memory Foam. Polyurethane Memory Foam. Polyurethan Memory Foam.
- 7: Nastri elastici intrecciati. Elastic belts interwoven. Geflochtene elastische Gurte.

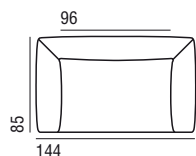

**DIVANO 144**  
LATERALE ANGOLO 144 DX - SX

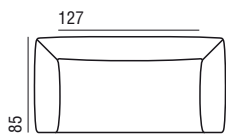

**DIVANO 175**  
LATERALE ANGOLO 175 DX - SX

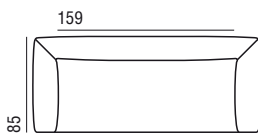

**DIVANO 207**  
LATERALE ANGOLO 207 DX - SX

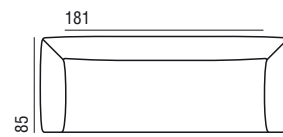

**DIVANO 229**  
LATERALE ANGOLO 229 DX - SX

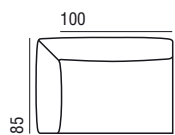

**LATERALE 124 SX**  
ANGOLO 124 SX

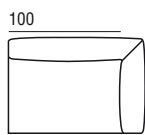

**LATERALE 124 DX**  
ANGOLO 124 DX

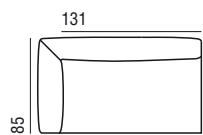

**LATERALE 155 SX**  
ANGOLO 155 SX

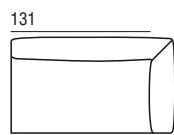

**LATERALE 155 DX**  
ANGOLO 155 DX

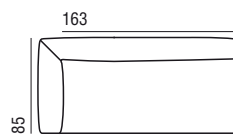

**LATERALE 187 SX**  
ANGOLO 187 SX

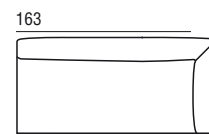

**LATERALE 187 DX**  
ANGOLO 187 DX

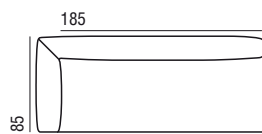

**LATERALE 209 SX**  
ANGOLO 209 SX

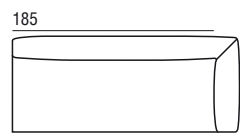

**LATERALE 209 DX**  
ANGOLO 209 DX

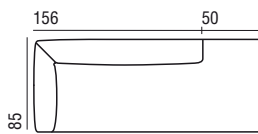

**DORMEUSE 206 SX**

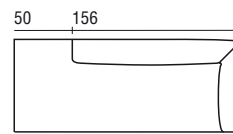

**DORMEUSE 206 DX**

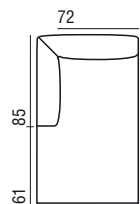

**CHAISE LONGUE SX**

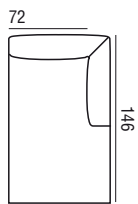

**CHAISE LONGUE DX**

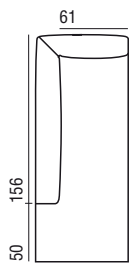

**DORMEUSE ANGOLO SX**

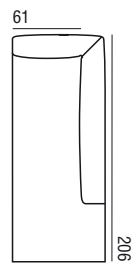

**DORMEUSE ANGOLO DX**

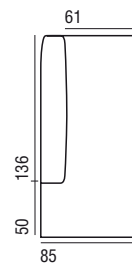

**TERMINALE 186 SX**

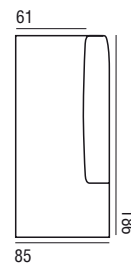

**TERMINALE 186 DX**

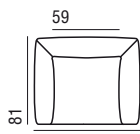

**POLTRONA**

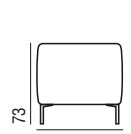

**FIANCO**

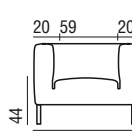

**FRONTE**

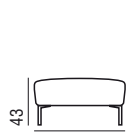

**FIANCO POUF**

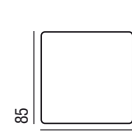

**POUF 85x85**

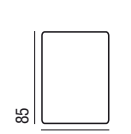

**POUF 62x85**



**CUSCINO 42x42**



**CUSCINO 54x33**



**CUSCINO POGGIARENI 86**

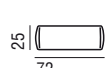

**CUSCINO POGGIARENI 72**



**CUSCINO POGGIARENI 56**



**CUSCINO POGGIARENI 40**

Descrizione composizioni fotografate - Description of the photographed combinations - Beschreibung der abgebildeten Zusammenstellungen

Foto pagina - photo at page - Bild auf Seiten: 62/63

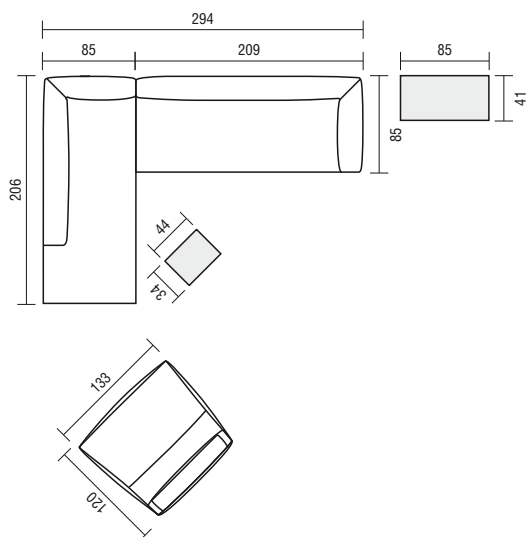

- |                              |                                |                                   |
|------------------------------|--------------------------------|-----------------------------------|
| 1 dormeuse angolo SX         | 1 corner dormeuse SX           | 1 Eckdormeuse SX                  |
| 1 laterale 209 DX            | 1 side piece 209 DX            | 1 Seitenteil 209 DX               |
| 1 Zoe poltrona XL            | 1 Zoe XL armchair              | 1 Zoe XL Sessel                   |
| 1 tavolino Blog rettangolare | 1 Blog rectangular small table | 1 rechteckiger Beistelltisch Blog |
| 1 tavolino Blog XL           | 1 Blog coffee table XL         | 1 Beistelltisch XL Blog           |

Foto pagina - photo at page - Bild auf Seiten: 66/67

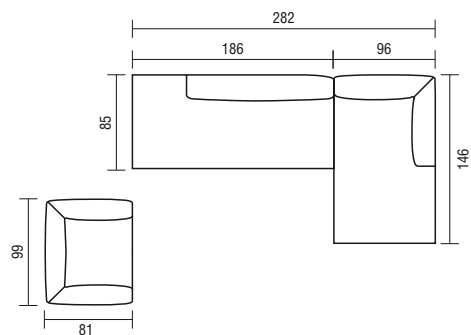

- |                    |                    |                     |
|--------------------|--------------------|---------------------|
| 1 chaise longue DX | 1 chaise longue DX | 1 Chaiselongue DX   |
| 1 terminale 186 SX | 1 end piece 186 SX | 1 Endelement 186 SX |
| 1 poltrona         | 1 armchair         | 1 Sessel            |

FINITURE - FINISHING - AUSFÜHRUNGEN



Cucitura Punto Cavallo  
Stitching Punto Cavallo  
Ziernaht Punto Cavallo



Cucitura ribattuta semplice  
Single lapped seam  
einfache Kappnaht



Cucitura versione tessuto Punto Cavallo  
Fabric version stitching Punto Cavallo  
Stoffversion Zierstich Punto Cavallo



Cucitura versione pelle solo ribattuta semplice con tasca chiusa  
Leather version single lapped seam only closed pocket  
Lederversion einfache Kappnaht Nur mit geschlossener Falte



**Verzelli**  
Strada Langhirano, 215  
43124 Parma (Italy)  
ph +39 0521 648111  
fx +39 0521 648626  
www.verzelli.it  
verzelli@verzelli.it

**Artwork:**

Art direction  
Corrado Mantovani  
Antonella Frezza

Graphic design  
Europa.it

Interior styling  
Antonella Frezza

**Credits:**

Photographer  
Alberto Tagliabue

Verzelli Photo Archive

L'Azienda si riserva di apportare ai suoi prodotti,  
senza alcun preavviso, tutte le modifiche tecniche  
e/o estetiche ritenute opportune.

The Company reserves the right to introduce  
all the technical and/or aesthetical modifications deemed  
necessary to their products, without prior notice.

Copyright © 2018 Verzelli  
Printed in Italy

